

Varenummer: 03551070

Beskrivelse: Fluro hydraulik ledhoved FPR 70CE

## Mål

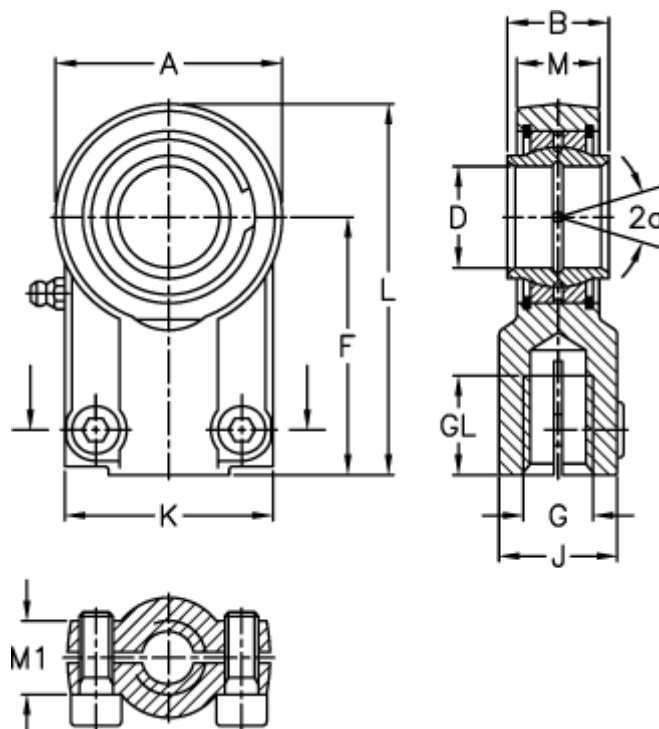

A	= 155	J	= 80
a (grader)	= 4	K	= 135
B	= 70	L	= 245
D	= 70	M	= 57
Dynamisk belastning C (kN)	= 315	M1	= 42
F	= 160	Moment (Nm)	= 210
g	= M56x2	Statisk belastning C0 (kN)	= 540
GL	= 81	Vægt	= 10100